

	Door Latch Sets	372 - 374
	Latches / Pulls / Catches	375 - 380
	Barrel Bolts / Hasps / Door Hooks	381 - 384
Cabinet Hardware	Handles	385 - 386
	Hinges	387 - 392
	Coat & Utility Hooks	392 - 393
Brackets		394
Storage Clips		394 - 395
Rubber Clamps		395
Fastmount		396 - 397

Determining the bevel required on a LOCK or LATCH

When standing outside if the door opens away from you then you need a lock or latch with a regular bevel. But if the door opens toward you then you need a lock or latch with a reverse bevel.

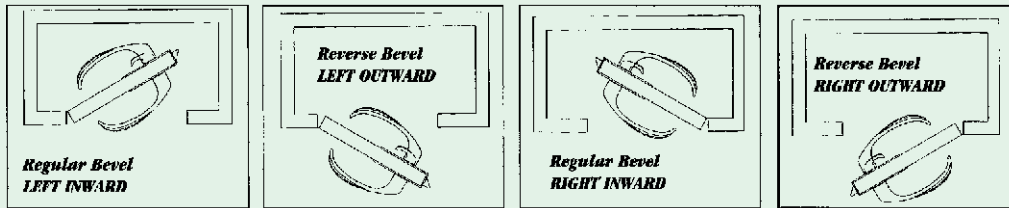

Perko Mortise Lock Set

- Chrome plated zinc
- Locked by dead bolt from inside, or key from outside
- For doors: 1" to 1-3/8"
- Case size: 2-3/4" x 2"
- Escutcheon plate: 4-3/8" x 1-1/4"

PER 927-DP-CHR

Replacement Parts:

PER 962-000-CHR	Knob and handle assembly
PER 920-DP-CHR	Reverse bevel and cam
PER 913-DP-CHR	Flush strike plate



Perko Mortise Latch Set

- Chrome plated zinc
- Locked by dead bolt from inside, no keys
- For doors 1" to 1-3/8"
- Case size: 2-1/4" x 1-13/16"

PER 960-DP-CHR

Replacement Parts:

PER 962-000-CHR	Knob and handle assembly
PER 960-000-99A	Bevel and cam



Perko Mortise Latch Sets

- Chrome plated zinc
- Sliding lock knob
- For doors: 1/2" - 3/4"
- Case dimensions: 1-5/8" x 1-5/8"
- Escutcheon plate: 2" x 2-1/4"

PER 991-DP0-CHR Regular bevel with flush strike, inward opening door

Replacement Parts:

PER 912-DP-CHR	Flush strike plate
PER 920-DP-CHR	Reverse bevel and cam
PER 984-000-CHR	Regular bevel and cam



Perko Mortise Latch Sets

Mortise type door locks are designed for interior applications such as head enclosures and areas of the ship where security is needed.

- Chrome plated zinc, brass and plastic
- New contemporary styling
- Overall height 5-1/4"
- Safety unlock from outside
- Interior lock mechanism
- Chromed escutcheon plates

PER 710-001-LIC

Left in or right out 3/4"-1"

PER 710-001-RIC*

Right in or left out 3/4"-1"

PER 710-002-LIC*

Left in or right out 1" - 1-1/4"

PER 710-002-RIC*

Right in or left out 1" - 1-1/4"

* Request Item



Perko Rim Latch Sets

- Chrome plated zinc
- Locked by slide button from inside, no keys
- For doors: 5/8" to 1-3/8"
- Case size: 2-1/8" x 1-3/4"

PER 928-DP-CHR Regular bevel with bo strike, inward opening door

PER 930-DP-CHR Reverse bevel with flush strike, outward opening door

Replacement Parts:

PER 962-000-CHR	Knob and handle assembly
PER 920-DP-CHR	Reverse bevel and cam
PER 984-000-CHR	Regular bevel and cam
PER 976-CHR	Bo strike
PER 912-DP-CHR	Flush strike



928



930

Perko Rim Latch Sets

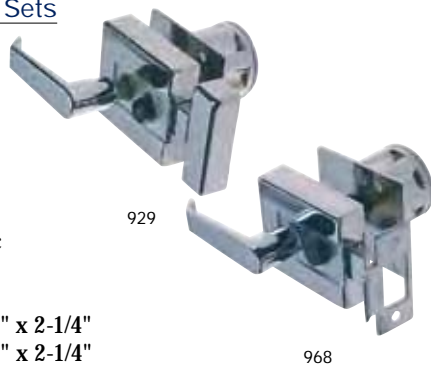

- Chrome plated zinc
- Sliding lock button
- For doors: 1/2" - 1"
- Case dimensions: 2" x 2-1/4"
- Escutcheon plate: 2" x 2-1/4"

PER 929-DP-CHR Regular bevel with bo strike, inward opening door

PER 968-DP-CHR Regular bevel with flush strike, inward opening door

Replacement Parts:

PER 912-DP-CHR Flush strike plate

PER 920-DP-CHR Reverse bevel and cam

PER 984-000-CHR Regular bevel and cam

PER 977-CHR Bo strike plate

Perko Rim Lock Sets

- Chrome plated zinc
- Locked by dead bolt from inside, or key from outside
- For doors: 5/8" to 1-3/8"
- Case size: 3-7/8" x 2"
- Escutcheon plate size: 4-3/8" x 1-1/4"



PER 918-DP-CHR Regular bevel with bo strike, inward opening door.

PER 919-DP-CHR Reverse bevel with flush strike, outward opening door

Replacement Parts:

PER 962-000-CHR Knob and handle assembly

PER 920-DP-CHR Reverse bevel with cam

PER 913-DP-CHR Flush strike plate

PER 918-000-99A Bo strike plate for 918

Perko Tubular Latch Set

- Chrome plated zinc
- Locked by dead bolt from inside, no keys
- For doors: 1" to 1-3/8"
- Tube diameter: 3/4"
- Escutcheon size: 4-3/8" x 1-1/4"



PER 567-DP-CHR

Replacement Parts:

PER 962-000-CHR Knob and handle assembly

PER 912-DP-CHR Flush strike

Perko Cup Rim Latch Set

- Regular bevel with strike box
- Chrome plated zinc
- For door thickness 5/8" to 1"
- Comes with black plastic spacer for surface mounting
- Case 2" x 2-1/4", Cup OD: 2-1/4"



PER 1239-DP-CHR

Replacement Parts:

PER 912-DP-CHR Flush strike plate

PER 920-DP-CHR Reverse bevel and cam

PER 984-000-CHR Regular bevel and cam

PER 977-CHR Bo strike plate

Perko Lock & Latches

- Chrome plated zinc and black impact resistant plastic
- Stainless steel stem and lock nut
- Comes with offset cam bar and flexible plastic strike plate
- Easily installs in a 2" diameter hole
- Detents indicate open or closed position
- For doors: 1/4" to 1-1/8" thick
- Adjustment latch bar: 3/8" - 3"
- Face plate dimensions: 2-1/2" x 2-1/2"

Locking latch with two keys. Offset cam bar with flexible plastic strike.

(As shown in picture)



PER 931-DP1-BLK

Locking latch with two keys. Offset adjustable cam bar.

PER 931-DP2-BLK

Non-locking latch. Offset cam bar with flexible plastic strike

PER 932-DP1-BLK

PER 932-DP1-WHT



Non-locking latch. Offset adjustable cam bar.

PER 932-DP2-BLK

Hinged water resistant cover fits 931 and 932 lock and latch assemblies. Black, fibre reinforced plastic.

PER 1089-DP1-BLK

Parts:

PER 931-002-99A Offset adjustable cam bar



Perko Lock and Latches

- Large handle allows two finger grip
- Chrome plated zinc and black impact resistant plastic
- Stainless steel stem and lock nut
- Flush mounts in a 2-3/8" x 2-3/8" hole
- Surface mounts in a 1-5/8" diameter hole
- For doors: 1/8" - 3/4" thick
- Adjustment latch bar: 1/2" - 3"
- Face plate dimensions: 3-1/8" x 3-1/8"

PER 1031-DP1-BLK Locking latch with 2 keys
 PER 1032-DP1-BLK Non-locking latch

- Hinged water resistant cover fits 1031 and 1032 lock and latch assemblies
- Black, fibre reinforced plastic

PER 1089-DP3-BLK

Perko Hatch Dog

- For securely fastening deck hatches
- Chrome plated brass, stainless steel lock nuts
- Comes with flush strike
- For hatches up to 2" thick
- Use #8 fasteners



Part #	Face Plate L x W	Max. Adjustment Latch Bar
PER 777-000-CHR	3-13/16" 3"	1-1/4" - 2"

Perko Lock and Latches

- Chrome plated zinc
- Stainless steel tumbler assembly
- Locking or non-locking versions
- For doors: 1/2" to 3/4"
- Size: 2-1/4" x 2"

PER 921-DP-CHR Locking type w/2 keys
 PER 922-DP-CHR Non-locking

Parts:
 PER 980A Spare cam bar (chrome) for 921 & 922

Perko "T" Handle Lock and Latches

- Black plastic body, handle is zinc and stem is stainless steel
- Rubber seals the lock cylinder preventing water intrusion
- Face plate dimensions: 3"
- Fits into a 2-1/2" diameter hole
- Mounting surfaces: 1/8" to 3/4"
- DP1 Adjustable cam bar: 3/4" to 2-3/8"
- DP4 Adjustable cam bar: 1/2" to 3"

PER 1091-DP1-BLK Locking style comes with 2 keys

PER 1092-DP1-BLK Latch (Non locking)

PER 1092-DP4-BLK Latch XL cam bar (Non locking)

Sea-Dog Mount Locking Lifting Ring

- Stamped 304 stainless steel, with die cast lock
- Comes with two types of locking arms for either flush or offset installations
- Faceplate: 2-1/8" x 1-15/16"
- Cutout: 3/4"

SED 221831-1

Sierra Cam Locks

- Complete with mounting hardware
- Cutout diameter: 3/4"

SIE CL49310 For panels up to 5/8"

SIE CL49320 For panels up to 3/4"

SIE CL49330 For panels up to 1"

Sea-Dog Cam Lock

- Stamped 304 stainless/die cast zinc
- Comes with two matching keys
- Includes flush and offset cams
- Cutout diameter: 3/4"

SED 221930-1 For panels up to 5/8"



Sea-Dog Round T-Handle Latch

- Investment cast 316 stainless steel
- Dia: 2-7/16" x Depth: 1-3/8"
- Cutout: 2"

SED 221910

Gemlux Lift Pulls

- Cast stainless steel
- 2 finger pull
- Totally positive "shut" feel with a 180° turn
- Includes a backing plate, straight and offset cams

GEM 3302260-1 3-1/2"

GEM 3302264-1 2-1/2"

Gemlux Slam Latches

- Cast stainless steel
- Spring loaded, 2 finger pull
- Totally positive "shut" feel with a 180° turn
- Mounting brackets for panels over or under 1/2" thick
- Locking or non-locking styles
- 2" hole installation

GEM 3305151 Non-locking

GEM 3305154 Locking

T-H Marine Slam Latches

- Oval-top, nautical design
- Low profile
- Totally corrosion resistant
- UV stable, resistant to chemicals, acetone, alcohol and gasoline.
- Stainless steel pawl catch & mounting hardware
- 2" hole installation
- Fits lids: 1/16" to 7/8"

THM NFSL-5-1-DP Black

THM NFSL-5-2-DP White

Sea-Dog Flush Mount Slam Latches

- Injection molded nylon
- Dia: 2-7/16" x Depth: 1-1/2"
- Use #12 RH fasteners

SED 228120-1 White

SED 228125-1 Black

Sea-Dog Watertight Slam Latch

- Investment cast 316 stainless
- Diameter: 2-3/8" x D: 1-11/16"
- Use 1/8" RH fasteners

SED 221962

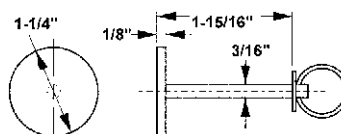
Sea-Dog Hatch Cover Pull

- 304 stamped stainless steel

SED 221840-1

ITC Hatch Lift Pins

- Stainless steel lift pin, washer and retaining ring
- Rubber "grommet" protects gel coat and reduces rattle
- Head is 1-1/4" diameter, pin is 1/4" x 2" length

ITC 84250 3"

ITC 84251 2"

Sea-Dog Hatch Handle

- Chrome plated brass
- 3" x 2-1/8"
- Use #8 FH screws

SED 222420-1

Sea-Dog Hatch Handle

- Stamped stainless steel, with a spring return
- 3" x 2-1/4"
- Use #8 fasteners

SED 221820-1

Sea-Dog Hatch Handle

- Investment cast 316 stainless steel
- 3" x 2-1/8"
- Use #8 fasteners

SED 221860

Sea-Dog Hatch Handles

- Cast brass
- 2-15/16" x 2-13/16"
- Use #8 FH screws

SED 222425-1 Chromed brass

SED 222426-1 Brass

Perko Lifting Handles

- Available in chrome plated brass or zinc
- Size: 3" x 2-1/4"
- Inside handle: 1-7/8" x 1"
- Use: #8 fasteners

PER 1220-DP-CHR Chrome plated zinc

PER 776-DP1-CHR Chrome plated brass



Perko Lifting Handle

- Chrome plated cast bronze
- Size: 3-3/4" x 2-3/4"
- Inside handle: 2-3/16" x 1-3/16"
- Use: #8 fasteners

PER 776-DP2-CHR



Sea-Dog Ring Pull

- Cast brass
- 1-7/16" x 1-3/16"
- Use #4 fasteners

SED 222395-1



Sea-Dog Ring Pulls

- Cast brass

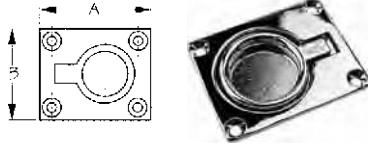

Part #	A	B	Finish	Fastener
SED 222400-1	1-3/4"	1-1/2"	Chrome	#6 FH
SED 222405-1	1-3/4"	1-1/2"	Brass	#6 FH
SED 222410-1	2-1/2"	2"	Chrome	#8 FH
SED 222415-1	2-1/2"	2"	Brass	#8 FH

Sea-Dog Lift Handles

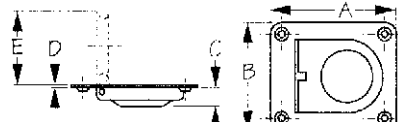

- Stamped 304 stainless steel
- Pull handle is spring loaded to stay closed



Part #	A	B	C	D	E	Fast
SED 221810-1	2-9/16"	2-3/16"	7/16"	1/32"	1-1/2"	#8 FH
SED 221815-1	1-3/4"	1-1/2"	7/16"	1/32"	1"	#6 FH

Sea-Dog Ring Pull

- Investment cast 316 stainless steel
- 1-15/16" x 1-9/16"
- Use #8 fasteners

SED 221850-1



Perko Ring Pull

- Chrome plated zinc
- 1-3/4" x 1-3/8"
- Use #6 fasteners

PER 841-DP-CHR



Perko Ring Pull

- Chrome plated bronze
- 2-9/16" x 2"
- Use #8 fasteners

PER 1103-DP-CHR



Perko Ring Pulls

- Chrome plated zinc
- Use #6 fasteners

PER 1232-DP1-CHR
PER 1232-DP2-CHR

1-5/8"
2"



Perko Ring Catch

- Chrome plated zinc
- Bronze spring
- 2-1/4" x 1-3/8"
- Use #6 fasteners

PER 1051-DP-CHR



Perko Pull

- Chrome plated zinc with black plastic finishing flange
- Spring loaded
- 3-1/4" L x 3/4" W
- Use #8 fasteners

PER 1221-DP-CHR



Perko Door Button

- Chrome plated zinc
- Black plastic knob
- Diameter: 1-3/4"
- Use #6 F.H. fasteners

PER 1216-DP-CHR



Sea-Dog Door Buttons

- Brass
- Dia: 1-3/4"
- Use #6 FH fasteners

SED 222360-1 Chromed
SED 222365-1 Brass



Sea-Dog Cupboard Bolt

- Chrome plated extruded brass
- W: 2-1/4 x H: 1-1/2"
- Use #5 F.H. fasteners

SED 222380-1



Perko Cupboard Bolt

- Chrome plated zinc with black plastic slide and knob
- 2-1/8" x 1-1/2"
- Use #6 F.H. fasteners

PER 1101-DP-CHR



Perko Latch

- Chrome plated zinc with sliding lock button
- Overall size: 2-1/8" x 2-1/4"
- Use #6 F.H. fasteners

PER 948-DP-CHR

Parts:

PER 984-000-CHR Spare bevel with cam
 PER 976-CHR Spare strike plate



Perko Cupboard Catches

- Chrome plated zinc
- Overall size: 1-1/2" x 1-7/8"
- Use #6 F.H. fasteners

PER 1102-DP1-CHR

Flush

PER 1102-DP2-CHR

Offset



Cruiser

Push Button Maxi Latches

- Unit opens and closes with pressure
 - Body is made of plastic and knobs and dress rings are made of stainless steel
 - Strike plate is made of nickel
- * **ote*** Order 4 parts each for a complete package.

CRU 374966 Large body, 5.5 cm 4.5 cm
 CRU 374990 Large strike plate
 CRU KNOB/SS/LG Large S/S knob
 CRU RING/SS/LG Large S/S ring
 CRU 374971 Small body, 3 cm 3.5 cm
 CRU 374991 Small strike plate
 CRU KNOB/SS/SM Small S/S knob
 CRU RING/SS/SM Small S/S ring



Lamp Push Knob With Latches

Pushing in the knob activates and secures the latch so the door will not open until the knob is pushed again.

- Zinc die cast with chrome or gold finish
- Fits 19/32" to 63/64" thick doors
- Left side latching, comes with screws

LMP PKL-08/CR Chrome push knob
 LMP PKL-08/GA Gold push knob
 LMP PKL-S/BLK Black plastic latch body
 LMP PKL-S/WHT White plastic latch body
 LMP PKL-SP-WHT White plastic spacer plate 2 mm

* Note - Order a push knob and body for a complete set.



Lamp Push Button Catches

- Plastic with a choice of knob finish
- Material: Latch Body - Polyamide
- Supplied with stainless steel screws
- L: 57 mm x H: 56 mm x D: 27 mm

Knobs

LMP TLP-BB/CR Chrome
 LMP TLP-BB/PB Polished brass
 LMP TLP-BB/SN Satin nickel

Bodies

LMP TLP-LB/WHT Bar latch body white
 LMP TLP-LBM/WHT Latch body white



Sea-Dog Push Button Cabinet Latch

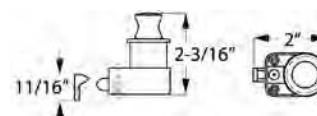

- Chrome plated brass button
- Plastic body

SED 226312-1

Packaged



Sea-Dog Push Button Rim Latches

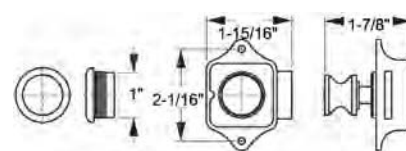

- Brass or stainless and plastic construction
- Complete with two strike plates
- Hole spacing on flat strike plate is 1-7/8"
- Hole spacing on 90 degree strike plate is 1-3/16"
- #4 FH fasteners
- Recommended door thickness 7/8"
- Latch fastener: #6

SED 224300-1 Polished chrome
 SED 224301-1 Polished brass
 SED 225300-1 Stainless steel



Attwood Glove Box

- Black plastic box and door
- Stainless steel hinge pin
- Lockable and comes with 2 keys
- Inside box: 11-3/4" L x 4" W x 6-5/8" D
- Door: 13-3/4" L x 5-1/2" W
- Installation hole: 12" x 4-1/4"



ATT 2638-1

Parts:

ATT 2638-20-1 Replacement lock & keys

T-H Marine Glove Box

- Non-locking cam latch
- Positive lid seal for water tight fit
- Stainless steel hinges
- Hidden fasteners in frame size: outside 7-1/2" x 14-1/4"



THM GDS4-0714-1-DP Black

Sierra Glove Box Lock

- Black plastic lock for marine glove boxes
- Can be locked for security or left in latch only position
- Supplied with 2 keys
- Cutout diameter: 1"



SIE MP49410

Lamp Safe Push Latches

- Push to open, push to close
- No need for door handles or pulls
- Can not be pulled open
- Supplied with screws
- L: 71 mm x H: 40 mm x D" 16mm



LMP MC-37/BLK Black

LMP MC-37/WHT White

Lamp Magnetic Touch Latches

- Push to open, push to close
- May require a handle or knob
- Supplied with screws
- L: 38mm x H: 36 mm x D: 15 mm



LMP ML-80/BLK Black

LMP ML-80/WHT White

Southco Grabber Catch Latch

- Pull to open
- Catch snaps into frame
- Fits into frames from 1.1 (.043) to 7 (.276) thick
- Corrosion-resistant materials
- Spring-loaded over-centre latching
- Two opening tensions available



SCO C3-805 5 lb complete

SCO C3-810 10 lb complete

Parts:

SCO C3-97 Spare catch

Lamp Bar Catches

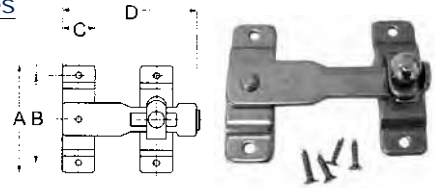

- 18-8 polished stainless steel
- Supplied with stainless steel fasteners

Part #	A	B	C	D
LMP BL-80	65mm	53mm	20mm	84mm
LMP BL-100	80mm	66mm	25mm	105mm

Buck Algonquin Transom Door Latch

- Stainless steel - 316
- Bracket size: 3" x 1-1/2"
- Bolt size: 1/4"
- Handle length: 6-1/4"



BUC 70TDLS-625SM

Complete

T-H Marine Pontoon Gate Latch

- All parts install on gate only
- Operates on right or left hinged gates
- Fits 1", 1 1/8" or 1 1/4" square tube
- Prevents gate from swinging inward
- Nylon molded parts, prevent rattling
- Easy installation

**ote** Not designed as a safety or load bearing device.

THM GL-2-DP

Grey

Lamp Rotary Catches

- White plastic
- Good for at least 300,000 operations
- Sold in bulk, each



LMP 6900/WHT 1-1/8" wide

LMP 6901/WHT 1-7/32" wide

Lamp K-Catch

- Natural white, 1-13/32"
- Sold in bulk, each



LMP K-CATCH/WHT

Sea-Dog
Spring Loaded Horizontal Mount Door Catch

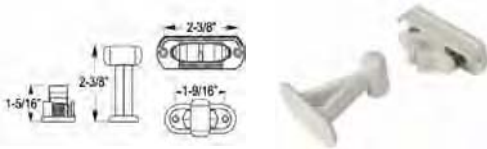

- Heavy-duty stainless steel springs provide an extremely strong catch mechanism to securely hold doors and hatches
- Stainless steel mounting screws included

SED 227181-1

Sea-Dog
Spring Loaded Vertical Mount Door Catch

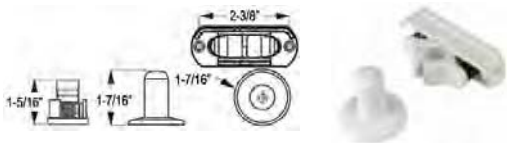

- Heavy-duty stainless steel springs provide an extremely strong catch mechanism to securely hold doors and hatches
- Stainless steel mounting screws included

SED 227186-1

Sea-Dog Roller Catch

- Injection molded nylon
- Surface mount
- Display package
- Use #8 fasteners

SED 227108-1

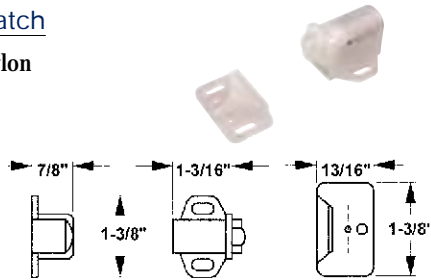

Sea-Dog Double Ball Catches

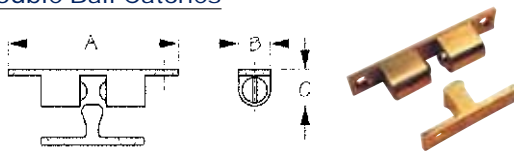

- Adjustable spring loaded ball catch
- Easy adjustment of the holding strength

Solid Brass					
Part #	A	B	C	Fast	Qty
SED 222841	1-11/16"	5/16"	3/8"	#4 FH	
SED 222841-1	"	"	"	"	2/pkg
SED 222842	1-15/16"	3/8"	7/16"	#4 FH	
SED 222842-1	"	"	"	"	2/pkg
SED 222843-1	2-5/16"	7/16"	1/2"	#6 FH	
Chromed Solid Brass					
SED 222822-1	1-15/16"	3/8"	7/16"	#4 FH	2/pkg
SED 222823-1	2-5/16"	7/16"	1/2"	#6 FH	2/pkg

-1 suffix denotes retail packaging

Perko Door Catches

- Black plastic
- Stud size: 1-1/8" x 3/8"
- Catch size: 1-3/8" x 7/8"
- Uses #4 fasteners

PER 559-DP 2/pkg



Perko Door Catches

- White plastic
- Comes with #8 screws
- Length: 1-1/4"

PER 554-DP 2/pkg



Perko Elbow Catch

- Chrome plated zinc
- Size: 1-1/8" x 9/16"
- Uses #6 fasteners

PER 1056-DP-CHR



Sea-Dog Elbow Catches

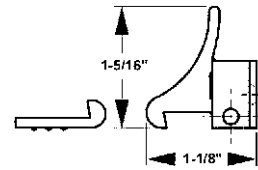

SED 222330-1 Chromed brass
SED 222335-1 Brass



Perko Plastic Elbow Catches

- Black plastic with integral spring
- Use #6 fasteners
- Size: 1-3/16" x 5/8"
- Uses #6 fasteners

PER 1021-DP-BLK 2/pkg



Perko Door Holder

- Stainless steel clip
- Chrome plated zinc arrow
- Base size: 1-5/8" x 3/4"
- Clip size: 1-3/8" x 7/16"
- Uses #8 fasteners

PER 1065-DP-CHR

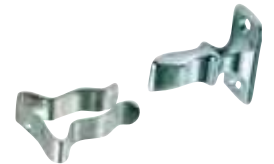

Perko Door Stop & Holders

- Chrome plated bronze with rubber bumper
- Diameter: 1-3/4"
- Stop uses #8 fasteners
- Catch uses #6 fasteners

PER 574-DP1-CHR 2-3/8" Long
PER 574-DP2-CHR 3-1/4" Long



Sea-Dog Door Stop & Catches

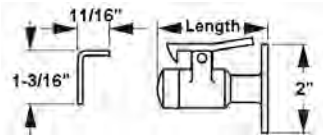

- White rubber bumper
- Stainless steel spring
- Use #6 fasteners
- Investment cast 316 stainless steel, cast brass or chromed brass

SED 221710	2-1/2", 316 stainless, bulk
SED 221710-1	2-1/2", 316 stainless, packaged
SED 221715	4", 316 stainless, bulk
SED 222710-1	2-1/2", Chromed brass, packaged
SED 222712-1	2-1/2", Brass, packaged

Lamp Magnetic Door Holders

- Made of plastic
- Supplied with screws
- Dia: 4.8 cm x Height: 9.3 cm

LMP SMDH/BRN	Brown
LMP SMDH/IVY	Ivory



Sea-Dog Magnetic Door Stop

- 304 stainless
- Use #10 fasteners
- Dia: 1-13/16" x H: 1-9/16"

SED 221750-1



Perko Door Stop

- Chrome plated zinc with rubber bumper
- Diameter: 1-1/4"
- Projection: 1"
- Use #6 fasteners

PER 1177-DP-CHR



Sea-Dog Door Bumpers

- Cast brass
- Use #6 fasteners
- Diameter: 1-7/8"

SED 222720-1	Brass chrome plated
SED 222722-1	Brass



Sea-Dog Sliding Door Stop

- Stainless steel
- L: 2-7/8" x W: 1-1/4"
- Use #8 fasteners

SED 221700-1



Perko Sliding Window Stop

- Chrome plated zinc
- Mounting plate size: 1-7/8" x 3/4"
- Stopping plate length: 1-1/2"
- Use #8 fasteners

PER 935-DP-CHR



Perko Sliding Window Handle

- Polished stainless steel
- For 1/4" thick glass
- Length: 3"

PER 954-DP-STs



Perko Sliding Window Locks and Anti-Rattlers



- Chrome plated zinc with black plastic knob and tip
- Use #6 fasteners

Part #	Height	Mounting Plate	Adjustment
PER 937-DP-CHR	1-5/8"	1" 5/8"	1-1/8"
PER 934-DP-CHR	1"	2" 5/8"	1-1/8"

Parts:

PER 944 Spare plastic tip for 934 & 937

Sea-Dog Anti-Rattle Window Fastener

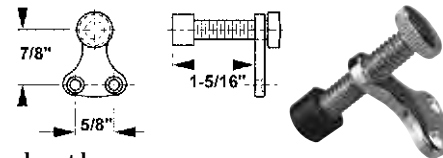

- Chrome plated sand cast brass
- Use #6 fasteners

SED 322210-1

Sea-Dog Windshield Brace Foot

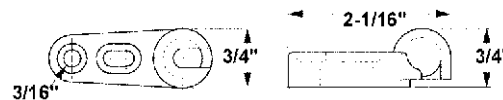

- Black injection molded nylon
- SED 324300-1

Sea-Dog Male Windshield Retainer Spacer

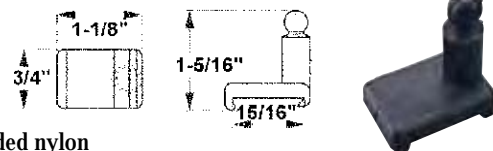

- Injection molded nylon

SED 324360-1

Sea-Dog Nylon Windshield Latches

- Black injection molded nylon
- Fastener hole: 3/16"
- 2/pkg

SED 324140-1	Single wing, 1-9/16"
SED 324210-1	Double latch, 1-11/16"



Cruiser Barrel Bolts

- Solid drawn brass
- Use #4 fasteners
- Width: 1"
- Pin diameter: 5/16"



Chrome/Brass	Polished Brass
CRU PC2002 2"	CRU PB2002 2"
CRU PC2002 2-1/2"	CRU PB2002 2-1/2"
-	CRU PB2002 3"
CRU PC2002 4"	CRU PB2002 4"

Sea-Dog Barrel Bolts

- Chrome plated extruded brass
- Use #6 fasteners
- 1/2" striker
- Height: 3/8"

SED 222500-1	1-1/2"
SED 222501-1	2"
SED 222502-1	2-1/2"
SED 222503-1	3"



Gemlux Barrel Bolt

- 316 cast stainless steel
- Slim line design
- Built-in anti-rattle friction plate
- Use #6 fasteners

GEM 3301486 4-3/4" 1"



Perko Barrel Bolt

- Chrome plated zinc
- Integral friction pad eliminates rattles and provides smooth operation
- Use #8 fasteners
- Overall: 3-3/8" x 1-1/4"

PER 1244-DP-CHR



Sea-Dog HD Barrel Bolts

- Investment cast 316 stainless.
- Use #8 FH fasteners

SED 221243-1	L 3-1/6"	W 1-1/2"
SED 221244-1	L 4-1/4"	W 1-1/2"



Perko Barrel Bolts

- Chrome plated bronze
- Black friction pad eliminates rattle and provides smooth operation
- Use #6 fasteners
- Width: 1-7/16"

PER 947-DP1-CHR	3-7/16" long
PER 947-DP2-CHR	4-5/16" long
PER 947-DP3-CHR	5-1/4" long



Lamp Spring Loaded Barrel Bolts

- 18-8 stainless steel
- Width: 33 mm
- Supplied with stainless steel screws

LMP BLS-60	85.4 mm long
LMP BLS-90	115.4 mm long



Sea-Dog Barrel Bolt

- Length: 2-7/8", striker: 3/4", H: 1/2"
- Chrome plated sand cast brass
- Use #6 fasteners

SED 222522-1



Marine East Barrel Bolt Slots

- Molded in high-impact nylon
- 3/8" diameter opening accepts a range of standard barrel bolts
- Installation: 5/8" hole

MEP 4400W* White
* Request Item



Nylon Slot Only

Lamp Slide Bar Catch

- Satin finish 18-8 stainless steel
- Supplied with stainless steel screws

LMP KR-50

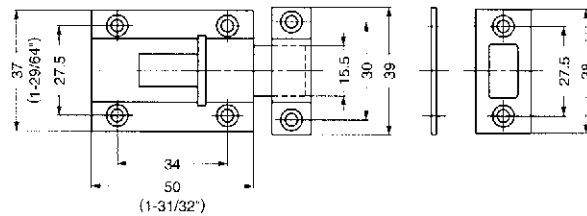
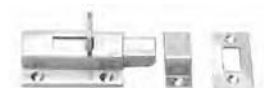

Lamp Gate Latches

- 18-8 stainless steel
- Supplied with stainless steel screws
- Packaged

Part #	A	B	C	D
LMP SSG-45	14mm	21mm	45mm	25mm
LMP SSG-65	20mm	30mm	65mm	33mm

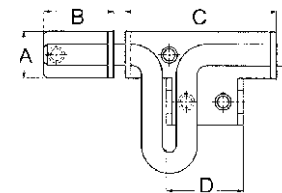

Perko Swivel Eye Hasp

- Chrome plated zinc
- Padlock eye swivels to act as a latch
- Use #6 fasteners
- Length: 3" x Width: 1"
- Padlock clearance: 11/32"



PER 1194-DP-CHR

Parts:

PER 1194-DP-99A Spare keeper

Perko Hasps

- Chrome plated zinc hasp
- Use #6 fasteners
- W: 1" x L: 3"
- Padlock clearance: 9/32"



PER 1198-DP1-CHR 2"

PER 1198-DP2-CHR 3"

PER 1198-DP3-CHR 3-3/4"

Perko Hasps

- Chrome plated bronze
- Use #6 fasteners
- W: 1". L: 3"
- Padlock clearance: 9/32"



PER 998-DP1-CHR 2"

PER 998-DP2-CHR 3"

Parts:

PER 959-DP-CHR Spare keepers, 2/pkg

Sea-Dog Safety Hasp

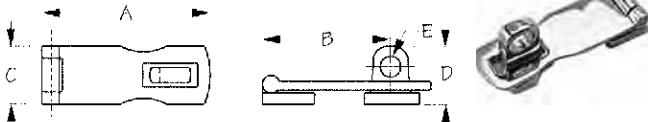

- Chromed cast brass
- Use #6 fasteners

Part #	A	B	C	D	E
SED 222140-1	3-1/2"	2-3/8"	1"	1"	3/8"

Sea-Dog Safety Hasps

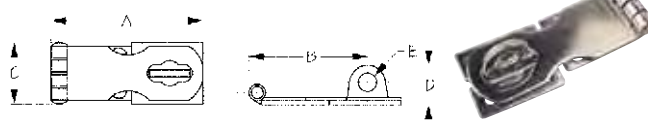

- Stamped 304 stainless steel
- Use #6 fasteners

Part #	A	B	C	D	E
SED 221120-1	2-11/16"	2-1/16"	1-1/16"	11/16"	5/16"
SED 221124-1	3-13/16"	3-1/16"	1-1/16"	11/16"	5/16"

Sea-Dog Swivel Hasp

- Stamped 304 stainless steel
- Staple swivels to act as a latch
- L: 2-11/16" x W: 1-1/16"
- Padlock clearance: 5/16"
- Use #6 fasteners



SED 221130-1

Sea-Dog Swivel Hasps

- Cast brass construction
- L: 3" x W: 1"
- Padlock clearance: 3/8"
- Use #6 fasteners



SED 222130-1

Chromed brass

SED 222135-1

Brass

Sea-Dog Heavy Duty Hasps

- Cast brass construction
- L: 4-1/4" x W: 1-9/16"
- Padlock clearance: 1/2"
- Use #8 fasteners



SED 222150-1

Chromed brass

SED 222155-1

Brass

Sea-Dog Heavy Duty Swivel Hasps

- Stamped 304 stainless steel
- L: 3-1/8" x W: 1-1/8"
- Padlock clearance: 3/8"
- Use #8 fasteners

221135



SED 221135-1

Flush

SED 221136-1

Angle

Sea-Dog Swivel Hasps

- Chrome plated zinc
- L: 3" x W: 1"
- Padlock clearance: 3/8"
- Swivel bale
- Use #8 fasteners



SED 224130-1

Flush

224130

SED 224131-1

Angle

Sea-Dog Hasp

- Cast chrome plated brass
- Use #6 fasteners
- L: 2-5/16" x W: 1"
- Padlock clearance: 3/8"



SED 222120-1

Sea-Dog Locking Hasp

- Stamped 304 stainless steel
- Use #8 fasteners
- L: 3-1/8" x W: 1-1/4"



SED 221150-1

Sea-Dog Anti-Rattle Latch

- Investment cast 316 stainless
- L: 3" x W: 1-1/2" x H: 3/4"
- Use #10 FH fasteners

SED 221100-1



Builders Hardware Draw Pull Catches

- Electro-polished stainless steel
- Lockable
- Use #6 fasteners

Large

- Base width: 1-5/8"
- Overall length: 3-3/8"

BHW 207-SS-1 Bulk



Small

- Base width: 1"
- Overall length: 2-1/2"

BHW 205-SS-1 Bulk

Perko Hold Down Clamp

- Chrome plated bronze
- Lockable
- Use #6 fasteners
- Size: 2-3/4" x 1-3/4"
- Padlock clearance: 1/4"

PER 1108-DP-CHR



Sea-Dog Anti-Rattle Fastener

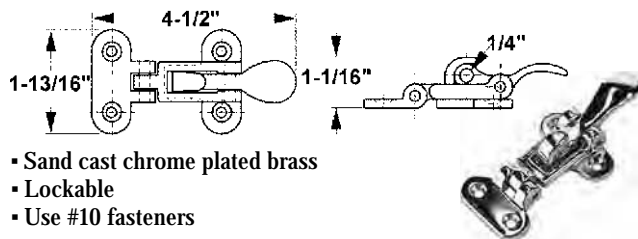

- Sand cast chrome plated brass
- Lockable
- Use #10 fasteners

SED 222110-1

Perko Hold Down Clamps



- Chrome plated bronze
- Use #8 fasteners

Part #	Description	Length	Width
PER 1112-DP-CHR	Flat Mount	3"	1-1/2"
PER 1113-DP-CHR	Angle Mount	2-1/2"	1-1/2"

Beckson Hold Down Clamp

- Stainless steel
- Twist knob pivots to adjust and fold back 90 degree for flush fit
- Length in closed position is 2"

BEC TDS-1



Perko Hatch Fastener

- Chrome plated bronze
- Length: 3-1/2". Width 1-5/8"
- Adjustment: 1-1/8"
- Use #8 fasteners

PER 770-DP-CHR



Perko Table Fastener or Windshield Keeper

- Chrome plated brass with black plastic knob
- Angle length: 1-3/8"
- Angle width: 1"
- Use #8 fasteners

PER 719-DP-CHR



Perko Hatch Fastener / Windshield Keeper

- Chrome plated brass and zinc
- Black plastic handle
- Base dimensions: 1-1/2" x 5/8"
- Use #8 fasteners

PER 769-DP-CHR

Parts:
PER 769-000-99C Spare handle with stud



Perko Windshield Keeper

- Chrome plated brass and zinc
- Bracket: 1-1/2" x 5/8"
- Keeper: 1-1/2" x 3/4"
- Use #8 fasteners

PER 697-DP-CHR



Perko Windshield Keeper

- Chrome plated bronze
- Bracket: 1-9/16" x 1"
- Keeper: 1-7/8" x 7/8"
- Use #8 fasteners

PER 967-DP-CHR



Perko Hatch Fastener

- Chrome plated brass with phosphor bronze spring
- Overall length: 3-7/8"
- Mounting base size: 1-1/2" x 9/16"
- Use #6 fasteners

PER 155-DP-CHR



Taylor Utility Latch

- Black nylon fastener
- Stainless steel mounting hardware
- Overall length: 2-5/8"
- Width: 1-11/16"
- Adjustment: 1/2"

TAY 551 2/pkg



Sea-Dog Door Hooks

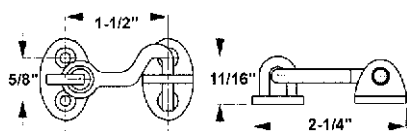

- Made from cast brass
- Use #6 fasteners

SED 222050-1 Chromed brass
 SED 222051-1 Brass



Perko Cabin Door Hooks

- Chrome plated zinc
- Use #6 fasteners

PER 1199-DP1-CHR 1-3/4"
 PER 1199-DP2-CHR 2-1/4"
 PER 1199-DP3-CHR 3"



Sea-Dog Door Hooks With Swivel

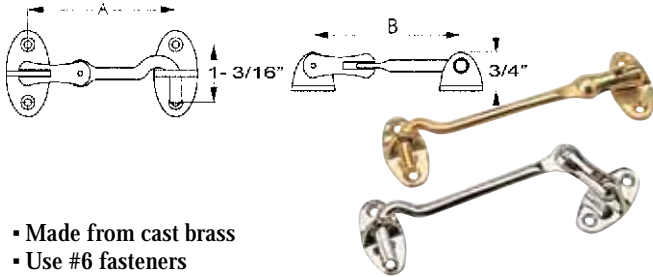

- Made from cast brass
- Use #6 fasteners

Part #	A	B	Material
SED 222080-1	3-1/8"	3"	Chrome
SED 222081-1	3-1/8"	3"	Brass
SED 222090-1	5-1/16"	5"	Chrome
SED 222091-1	5-1/16"	5"	Brass

Sea-Dog Door Hooks

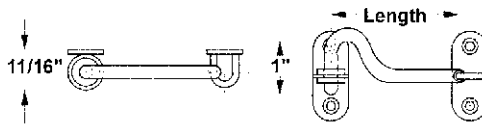

- Stainless steel
- Plastic bushing in the eye prevents accidental unhooking
- Use #8 fasteners

SED 221202-1 2-3/8" long
 SED 221203-1 3" long
 SED 221204-1 3-15/16" long



Sea-Dog Door Hooks

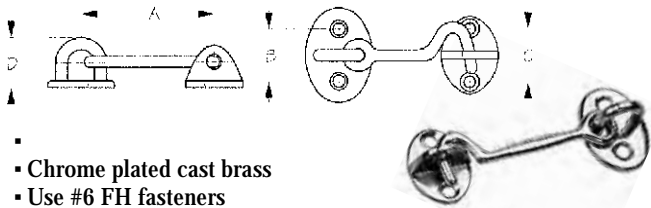

- Chrome plated cast brass
- Use #6 FH fasteners

Part #	A	B	C	D
SED 222112-1	2-1/2"	13/16"	13/16"	3/4"
SED 222113-1	2-3/4"	13/16"	13/16"	3/4"

Lamp Handles

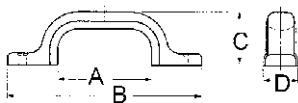

- Mirror finish. 304 stainless steel
- Synthetic rubber finger grip
- Supplied with screws



Part #	A	B	C	D	Pack
LMP US-70/M	20mm	70mm	28mm	17mm	Each
LMP US-160/M	88mm	160mm	37.5mm	22mm	Each

Buck Algonquin Stern Lifting Handle

- 316 polished stainless steel
- Base: 1" x 1-3/4"
- Overall: 5-3/4" x 1-3/4"
- Use #10 fasteners

BUC SLH-1



Lamp "FT" Series Handles

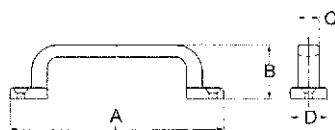

- Mirror finish 18-8 stainless steel
- Supplied with stainless steel screws



Part #	A	B	C	D	Pack
LMP FT-100	100mm	25mm	10mm	18mm	pkg
LMP FT-120	120mm	27mm	12mm	36mm	pkg
LMP FT-150	150mm	33mm	15mm	45mm	Bulk

Perko Handles

- Chrome plated zinc
- Inside height: 1-5/16"
- Length: 6"
- Inside length: 3-1/2"
- Use 1/4" fasteners

PER 1231-DP-CHR 2/pkg



Sea-Dog Lift Handle

- Die cast zinc chrome plated
- L: 5-7/8" x W: 2"
- Use #10 fasteners

SED 224260-1



Sea-Dog Lift Handles

- Cast brass
- L: 6" x W: 1-7/8"
- Use #8 fasteners

SED 222355-1 Chrome
SED 222356-1 Brass



Sea-Dog Lift Handle

- Chrome plated brass
- L: 4-3/4" x W: 1-1/4"
- Use #10 fasteners

SED 222340-1



Sea-Dog Deluxe Lift Handles

- Cast brass

No.	L	W	Finish	Fastener
SED 222345-1	4"	1"	Chrome	#8 FH
SED 222346-1	4"	1"	Brass	#8 FH
SED 222348-1	6"	1-5/16"	Chrome	#10 FH
SED 222349-1	6"	1-5/16"	Brass	#10 FH



Sea-Dog Lift Handle

- Chrome plated brass
- L: 5-3/4" x W: 1-3/4"
- Use #8 fasteners

SED 222350-1



▶ Also See Handrails pg 331

Sea-Dog Flush Pulls

- Injection molded Delrin
- L: 3-5/8" x H: 2-3/8" x D: 5/8"
- Use #6 fasteners

SED 227320-1 Black
 SED 227321-1 White
 SED 227322 Grey

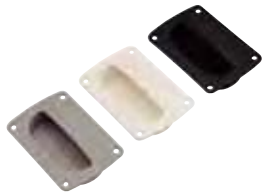

Perko Flush Pull

- Chrome plated zinc
- Size: 3-11/16" x 1-11/16"
- Depth: 7/16"
- Use #6 fasteners

PER 1110-DP-CHR



Perko Drawer Pull

- Chrome plated zinc
- Outside width: 3-7/16"
- Inside width: 2-5/16"
- Use #6 fasteners

PER 958-DP-CHR



Sea-Dog Flush Pulls

- Injection molded Delrin
- 1-5/8" square x D: 5/8"
- Use #6 fasteners

SED 227310-1 Black
 SED 227311-1 White



Perko Strap Hinges

- Chrome plated bronze
- 2 /pkg
- Use #10 fasteners

Part #	Length	Pin Width
PER 120-DP1-CHR	4"	1-1/8"
PER 120-DP2-CHR	6"	1-1/8"



Sea-Dog Strap Hinges

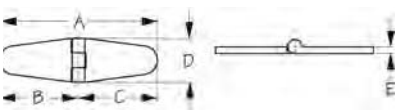

- Polished cast brass
- 2/pkg

Part #	A	B	C	D	E	Fastener
SED 204391-1	4"	2"	2"	1-1/16"	3/16"	#8 FH (4)
SED 204401-1	6"	3"	3"	1-5/16"	3/16"	#10 FH (6)

Sea-Dog Ladder Hinges

- Cast 316 stainless steel
- Highly polished finish
- L: 6-11/16" x W: 3/4"
- Use #10 fasteners

SED 205290-1 2/pkg



Sea-Dog Strap Hinges

- Chrome plated sand cast brass
- Use #8 fasteners
- L: 6" x W: 1-1/16"

SED 204400-1 2/pkg



Sea-Dog Strap Hinges

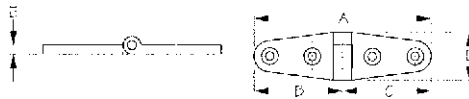

- Cast 316 stainless steel
- Highly polished finish
- 2/pkg
- Use #10 fasteners

Part #	A	B	C	D	E
SED 205390-1	4-1/8"	2-1/16"	2-1/16"	1"	3/16"
SED 205400-1	5-7/8"	2-15/16"	2-15/16"	1-1/8"	3/16"



Sea-Dog Strap Hinges

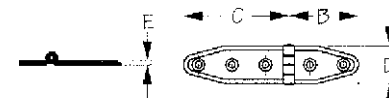

- Stamped 304 stainless steel
- 2/pkg
- Use #8 fasteners

Part #	A	B	C	D	E
SED 201134-1	4"	2"	2"	1-1/8"	1/8"
SED 201135-1	5-1/16"	2-1/32"	3-1/32"	1-1/8"	1/8"
SED 201136-1	6-1/8"	3-1/16"	3-1/16"	1-1/8"	1/8"



Sea-Dog Heavy Duty Strap Hinges

- Stamped 304 stainless steel
- L: 7-1/8" x W: 1-5/8"
- Use #8 fasteners

SED 201620-1 2/pkg



Sea-Dog Butt Hinges

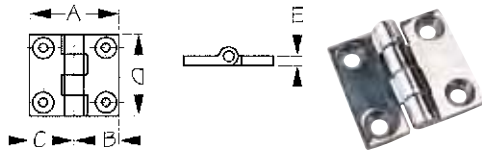

- Cast 316 stainless steel
- Use #10 fasteners

Part #	A	B	C	D	E	Pack
SED 205140	1-5/8"	13/16"	13/16"	1-1/2"	3/16"	Each
SED 205140-1	1-5/8"	13/16"	13/16"	1-1/2"	3/16"	2
SED 205142-1	2"	1"	1"	2"	3/16"	2

Sea-Dog Heavy Duty Hinges - Top Pin

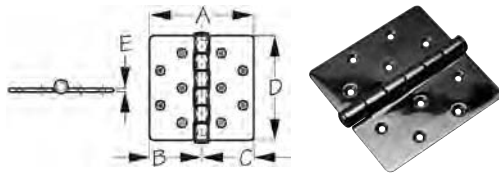

- Investment cast 316 stainless steel construction
- Designed for extra strength and corrosion resistance
- Silent movement and no rattle due to integral nylon bearings
- Use 1/4" fasteners

Part #	A	B	C	D	E
SED 205225	4"	2"	2"	4-1/2"	3/16"
SED 205227	5-1/2"	2-3/4"	2-3/4"	4-1/2"	3/16"

Sea-Dog Heavy Duty Hinges - Centre Pin

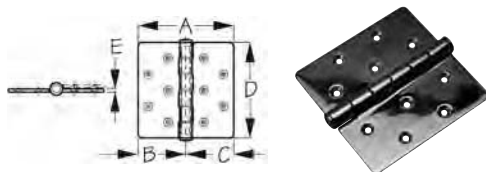

- Investment cast 316 stainless steel construction
- Designed for extra strength and corrosion resistance
- Silent movement and no rattle due to integral nylon bearings
- Hinge folds flat
- Use 1/4" fasteners

Part #	A	B	C	D	E
SED 205235	4"	2"	2"	4-1/2"	3/16"
SED 205237	5-1/2"	2-3/4"	2-3/4"	4-1/2"	3/16"
SED 205238	6"	3"	3"	6"	3/16"

Sea-Dog Butt Hinges

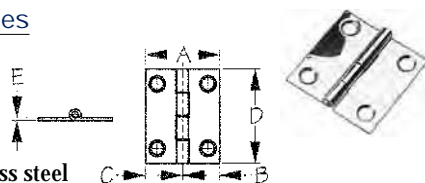

- Stamped 304 stainless steel
- 2/pkg
- Use #6 fasteners

Part #	A	B	C	D	E
SED 201070-1	1-1/4"	5/8"	5/8"	1-1/2"	1.2mm
SED 201071-1	1-5/8"	13/16"	13/16"	2"	1.2mm
SED 201072-1	2"	1"	1"	2"	1.5mm

Sea-Dog Butt Hinges

- Stamped 304 stainless steel hinge
- Use #8 fasteners
- L: 3" x W:2"

SED 201080-1 2/pkg



Sea-Dog Butt Hinges

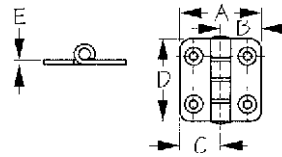

- Stamped 304 stainless steel
- Use #8 fasteners

Part #	A	B	C	D	E	Pack
SED 201580	1-3/8"	11/16"	11/16"	1-1/2"	1/16"	Each
SED 201580-1	1-3/8"	11/16"	11/16"	1-1/2"	1/16"	2
SED 201582-1	2"	1"	1"	2"	1/16"	2

Cruiser Butt Hinges

- Heavy duty extruded brass with brass pin
- Plain brass or chrome plated finish
- Sold by each

Part #	Fastener
Brass	
CRU SC 1-1/2"x1-1/2"	#4
CRU SC 2-1/2"x1-1/2"	#8
CRU SC 3"x2-1/2"	#8
CRU SC 3"x3"	#8
Chrome	
CRU PC 2-1/2"x1-1/2"	#8
CRU PC 3"x3"	#8



Cruiser Butt Hinges

- Natural nylon
- Stainless steel pin
- Sold by each

CRU 1202 2-1/2"	2-1/2"	1-11/16"	#6 screw
CRU 1202 3"	3"	1-15/16"	#6 screw
CRU 1202 4"	4"	2-3/8"	#8 screw



Sea-Dog Short Side Door Hinges

- Stamped 304 stainless steel
- L: 2" x W: 1-1/2"
- Use #8 fasteners

SED 201020-1 2/pkg
 SED 201020 Each

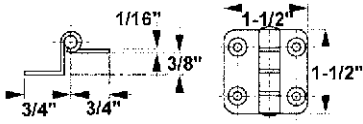
Sea-Dog Offset Butt Hinges

- Stamped 304 stainless steel
- Formed with a 3/8" offset for front surface of a raised door
- Use #8 fasteners

SED 201590-1 2/pkg

Perko Butt Hinge

- Chrome plated zinc butt hinge
- Has removable pin
- 2" x 2"
- Use #8 fasteners

PER 1293-DP4-CHR

Sea-Dog Hatch Hinges

- Cast 316 stainless steel
- L: 3-1/2" x W: 2-7/8"
- Use #10 fasteners

SED 205285 Bulk, each
 SED 205285-1 Packaged, each

Sea-Dog Hatch Hinges

- Cast 316 stainless steel
- L: 2-7/8" x W: 2-5/8"
- Use #10 fasteners

SED 205280-1 Split ring
 SED 205280R Quick release



205280R Detail

Sea-Dog Hatch Hinge

- Chrome plated brass
- L: 3" x W: 2-1/2"
- Use #10 fasteners

SED 204280-1 Each

Sea-Dog Take-Apart Hinges

- Cast 316 stainless steel
- L: 3-1/2" x W: 2"
- Use #10 fasteners

SED 205270-1 Left hand, 2/pkg
 SED 205275-1 Right hand, 2/pkg

Sea-Dog Locking Take-Apart Hinge

- Investment cast 316 stainless steel
- L: 3-1/2" x W: 2"
- Use #10 fasteners

SED 205276 Each

Sea-Dog Take-Apart Hinges

- Forged chrome plated brass
- L: 3-7/8" x W: 2"
- Use #10 fasteners

SED 204278-1 Left hand, 2/pkg
 SED 204279-1 Right hand, 2/pkg

Sea-Dog Flush Door Hinges

- Stamped stainless steel flush door hinge
- L: 2-7/8" x W: 1-1/2"
- Use #8 fasteners

SED 201535-1 2/pkg

Lamp Table Hinge

- Chromed brass table hinge
- L: 70mm x W: 40mm
- Use #8 fasteners

LMP SMH-40/CR Each

Lamp Table Hinges

- Solid brass
- L: 70mm x W: 30mm
- Sold by the each
- Use #8 fasteners

LMP SMH-30/CR Chrome finished
 LMP SMH-30/PB Polished finish



Gemlux Flush Mount Hinge

- Stamped stainless steel
- Knuckle sits below the hinge mounting surface
- Fits in recessed deck hatches or lids
- Allow 120 degrees of motion
- #6 fasteners
- 1-5/8" x 1-3/16"

GEM 1640 Each



NEW

Gemlux Flush Mount Hinge

- Investment cast stainless steel
- Knuckle sits below the hinge mounting surface
- Fits in recessed deck hatches or lids
- Allow 120 degrees of motion
- #10 fasteners
- 4" x 1-1/2"

GEM 3179 Each



NEW

Gemlux Flush Mount Hinge

- Stamped stainless steel
- Knuckle sits below the hinge mounting surface
- Fits in recessed deck hatches or lids
- Allow 120 degrees of motion
- #10 fasteners
- 3" x 1-1/2"

GEM 2643 Each



NEW

Sea-Dog Flush 2-Pin Hinges

- Stamped 304 stainless steel hinge
- L: 3-1/4" x W: 1-3/16"
- Use #6 fasteners

SED 201550-1 2/pkg

Sea-Dog Flush 2-Pin Hinges

- Stamped 304 stainless steel hinge
- L: 3" x W: 1-1/2"
- Use #8 fasteners

SED 201551-1 2/pkg

Sea-Dog Door Hinges

- Stamped 304 stainless steel
- L: 2-3/4" x W: 1-1/2"
- Use #8 fasteners

SED 201030-1 2/pkg

Sea-Dog Round Side Hinges

- Stamped 304 stainless steel
- L: 2-3/4" x W: 1-1/2"
- Use #8 fasteners

SED 201700-1 2/pkg

Sea-Dog Door Hinges

- Stamped 304 stainless steel
- L: 2-7/8" x W: 1-1/2"
- Use #8 fasteners

SED 201530-1 2/pkg

Sea-Dog Door Hinges

- Stamped 304 stainless steel
- L: 2-1/8" x W: 1-1/2"
- Use #8 fasteners

SED 201510 Bulk each
SED 201510-1 2/pkgSea-Dog Cuddy Hinge

- Stainless steel hinge
- L: 3" x W: 1-9/16"
- Use #8 fasteners

SED 201600-1 2/pkg

Sea-Dog Locker Hinges

- Stamped 304 stainless steel locker hinge
- L: 6" x W: 2-15/16"
- Use #6 fasteners

SED 201805-1 2/pkg

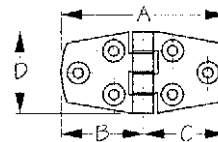
Sea-Dog Cuddy Door Hinges

- Cast 316 stainless steel, highly polished finish
- Use #10 fasteners

Part #	A	B	C	D	Pack
SED 205410	3"	1-1/2"	1-1/2"	1-1/2"	Each
SED 205410-1	3"	1-1/2"	1-1/2"	1-1/2"	Pair
SED 205420-1	4-1/8"	2-1/16"	2-1/16"	1-1/2"	Pair

-1 Suffix packaged.

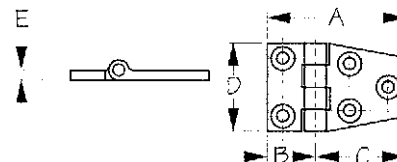
Sea-Dog Door Hinges

- Cast 316 stainless steel, highly polished finish
- 2/pkg
- Use #10 fasteners

Part #	A	B	C	D	E
SED 205310-1	2-3/8"	7/8"	1-1/2"	1-1/2"	3/16"
SED 205320-1	2-7/8"	3/4"	2-1/8"	1-1/2"	3/16"

Sea-Dog Round Hinge

- Cast 316 stainless steel
- Highly polished finish
- L: 3-1/4" x W: 1-3/16"
- Use #10 fasteners

SED 205460 Each

Sea-Dog Door Hinges

- Die cast chrome zinc
- L: 2-7/8" x W: 1-1/2"
- Use #8 fasteners

SED 206530-1 2/pkg

Sea-Dog Long Side Door Hinges

- Stamped 304 stainless steel
- L: 6" x W: 2-1/4"
- Use #10 fasteners

SED 201750-1 2/pkg

Perko Offset Hinges

- Chrome plated zinc
- 3/8" offset
- 2/pkg
- Use #8 fasteners

Part #	Size Open	Offset
PER 942-DP-CHR	1-1/2" 1-1/2"	3/8"

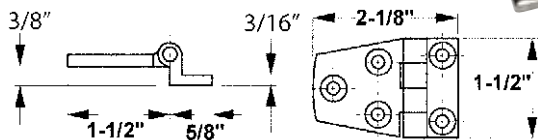
Sea-Dog Offset Hinges

- Investment cast 316 stainless steel
- Hinge is formed with a 3/8" offset
- Designed to be mounted on the front surface of a raised door
- Use #10 fasteners

SED 205350-1 2/pkg

Perko Inset Cupboard Hinges

- Chrome plated brass
- 3/8" inset
- Size: 2-3/4" x 2-1/8"
- Use #4 fasteners

PER 271-DP-CHR 2/pkg

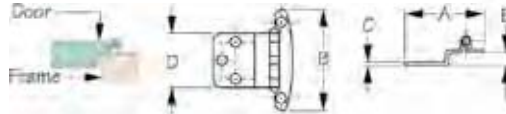
Sea-Dog Semi-Concealed Hinges

- Stamped 304 stainless steel or polished brass
- Use #6 fasteners

Part #		A	B	C	D	E	
SED 201914	S/S	2-3/16"	2-3/4"	1/16"	1-1/2"	3/8"	each
SED 201914-1	S/S	2-3/16"	2-3/4"	1/16"	1-1/2"	3/8"	2/pkg
SED 201915-1	Brass	2-3/16"	2-3/4"	1/16"	1-1/2"	3/8"	2/pkg
SED 201916-1	S/S	2-3/16"	2-3/4"	1/16"	1-1/2"	1/2"	each

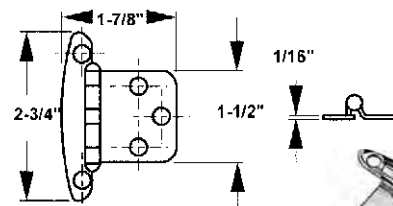
Sea-Dog Flush Mount Concealed Hinges

- Stamped 304 stainless steel/or polished brass
- Use #6 fasteners

SED 201954-1 S/S, 2/pkg
 SED 201955-1 Brass, 2/pkg

Perko Non-Mortised Hinges

- Chrome plated brass
- Pin height: 3-3/8"
- Width closed: 7/8"
- Use #8 fasteners

PER 957-DP-CHR 2/pkg

Lamp Hinges

- Mirror finish 18-8 stainless steel
- L: 127mm x W: 38.1mm
- Use #6 fasteners

LMP MA-5 2/pkg

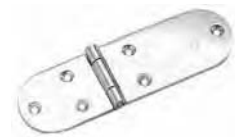

Lamp Hinge

- Satin finish 18-8 stainless steel
- L: 81mm x W: 30mm
- Use #8 fasteners

LMP SMH-83/S Bulk

Perko Cuddy Door Hinges

- Chrome plated bronze
- 2/pkg

Part #	Length	Width	Screw
PER 951-DP2-CHR	4"	1-1/2"	#8

Perko Cuddy Door Hinges

- Chrome plated zinc
- 2/pkg

Part #	Length	Width	Screw
PER 808-DP-CHR	3"	1-1/2"	#8

Perko "T" Hinges

- Chrome plated
- 2/pkg
- Use #10 fasteners

Part #	Length	Width	Height 'T' Side
PER 197-DP1-CHR	4"	2-1/8"	1-5/16"
PER 197-DP2-CHR	6"	3"	1-1/2"

Perko Door Hinges

- Chrome plated brass
- 2/pkg
- Use #6 fasteners

Part #	Length	Width
PER 924-DP-CHR	3"	1-1/2"

Perko Door Hinges

- Chrome plated bronze
- 2/pkg
- Use #8 fasteners

Part #	Width Open	Width Short Side	Height Pin
PER 999-DP-CHR	3-1/2"	1-1/2"	1-1/2"

Perko Door Hinges

- Chrome plated bronze or chrome plated zinc
- 2/pkg
- Use #8 fasteners

Part #	Length	Width	Material
PER 987-DP1-CHR	2-1/2"	1-1/2"	Chrome bronze

Perko Hinges

- Chrome plated zinc
- 2/pkg
- Use #8 fasteners

Part #	Size Open
PER 941-DP-CHR	1-1/2" 1-1/2"

Lamp Concealed Hinges

- Zinc alloy body and stainless steel link
- Fasteners supplied

Part #	A	B	C	D
LMP R-43	18mm	29mm	32mm	43mm
LMP R-60	22.2mm	35.2mm	47mm	60mm
LMP R-70	26.6mm	42.6mm	53.7mm	70mm

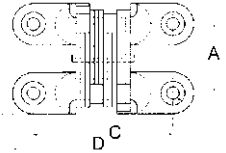
Sea-Dog Short Side Door Hinges

- Injection molded fibreglass nylon
- Stainless steel hinge pin
- L: 2-1/4" x W: 1-3/8"
- Use #8 fasteners

SED 202510-1 Black, 2/pkg
 SED 202511-1 White, 2/pkg

Sea-Dog Butt Hinges

- Injection molded fibreglass nylon
- L: 1-1/2" x W: 1-3/8"
- Use #8 fasteners

SED 202580-1 Black, 2/pkg
 SED 202581-1 White, 2/pkg

Sea-Dog Door Hinges

- Injection molded fibreglass nylon
- L: 3" x W: 1-3/8"
- Use #8 fasteners

SED 202530-1 Black, 2/pkg
 SED 202531-1 White, 2/pkg

Lamp Concealed Hinge

- Stainless steel self-closing
- 19mm coverage with 100° opening
- Come with 304 stainless steel screws

Hinge only

LMP 304B-C46/19 Bulk each

Mounting plate only

LMP 304B-P4A/32 Bulk each



Sea-Dog Piano Hinge

- 304 stainless steel
- 1-1/4" wide (open) x L: 36"
- Use #6 fasteners

SED 201850

Piano Hinges

- Sold in 6 foot lengths
- Please note that size given refers to the hinge when opened
- Approximately 48 screws per length needed
- 304 stainless steel
- Use #6 fasteners

LAR 1-1/4"x6'SS	1-1/4"	6'
LAR 1-1/2"x6'SS	1-1/2"	6'
LAR 2"x6'SS	2"	6'
LAR 3"x6'SS	3"	6'

Lamp Ball Point Hooks

- Polished 18-8 stainless steel
- Sold by each

LMP TL-15	21/32"
LMP TL-20	29/32"
LMP TL-30	1-1/4"
LMP TL-40	1-19/32"

S&J Cup Hooks

- Solid brass

Part #	Size	Pack
SAJ 480011	1/2"	8
SAJ 480021	5/8"	7
SAJ 480031	3/4"	7
SAJ 480041	7/8"	6
SAJ 480051**	1"	5



** Limited Quantity

Sea-Dog Lashing Hooks

- Injection molded nylon
- H: 7/8" x W: 3/4" x D: 5/8"
- Use #4 fasteners

SED 671420-1 Black, 5/pkg
 SED 671421-1 White 5/pkg

Sea-Dog Lashing Hooks

- Injection molded nylon
- H: 7/8" x W: 1-3/16" x D: 9/16"
- Use #10 fasteners

SED 671415-1 Black, 5/pkg

Sea-Dog Coat Hooks

- Black
- L: 2" x W: 1"
- Use #8 fasteners

SED 672709-1 2/pkg

Sea-Dog Hammock Hooks

- Stamped 304 stainless steel
- H: 15/16" x W: 1-1/4" x D: 1/2"
- Use #6 fasteners

SED 671460 Bulk, each
 SED 671460-1 2/pkg

Sea-Dog Coat Hooks

- Stainless steel construction
- W: 1-1/4" x H: 1-1/4" x D: 1-1/16"
- Use #6 fasteners

SED 671465-1 2/pkg

Perko Utility Hooks

- Chrome plated zinc
- 1/4" inside hook
- L: 15/16"L x W: 1/2"
- Use #6 fasteners

PER 1249-DP-CHR 5/pkg

Lamp Hook

- Polished stainless steel
- Comes with screws
- Bulk packaged

LMP EP-40

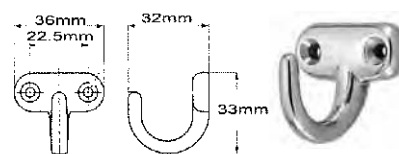

Lamp Hooks

- Polished stainless steel
- Comes with screws
- Bulk packaged

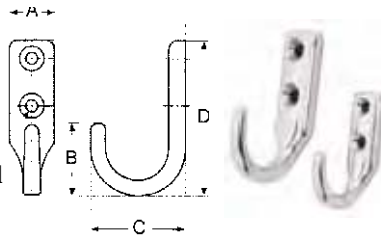

Part #	A	B	C	D
LMP EL-25	12mm	19mm	26mm	40mm
LMP EL-30	16mm	25mm	32mm	54.5mm

Lamp Hooks

- Polished stainless steel
- Comes with screws

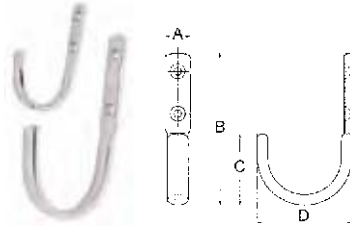

Part #	A	B	C	D	Pack
LMP JF-45	12mm	72mm	34mm	45mm	Bulk
LMP JF-70	16mm	120mm	55mm	68mm	Bulk

Sea-Dog Coat Hooks

- Investment cast 316 stainless

• H: 1-7/16" x W: 1-7/16" x D: 1"
 • Use #8 fasteners
 SED 671491-1 Single

• H: 1-7/16" x W: 2-9/16" x D: 1"
 • Use #8 fasteners
 SED 671492-1 Double



Sea-Dog Coat Hooks

- Cast brass
- H: 2-1/16" x D: 1-7/8"
- Display packaged, 2/pkg
- Use #6 fasteners

SED 671500-1 Chromed
 SED 671505-1 Brass



Sea-Dog Coat Hooks

- Cast brass
- H: 1-9/16" x D: 1-3/4"
- Display packaged, 2/pkg
- Use #6 fasteners

SED 671501-1 Chromed
 SED 671506-1 Brass



Perko Coat Hook

- Chrome plated zinc
 - W: 1-1/8" x D: 1-3/8"
 - Use #6 fasteners
- PER 610-DP-CHR



Perko Hat & Coat Hooks

- Chrome plated zinc
- Use #6 fasteners

No.	Depth	Width
PER 975-DP1-CHR	2"	1-1/8"
PER 975-DP2-CHR	3"	1-1/4"



Sea-Dog Triple Coat Hooks

- Cast brass
- H: 4-5/8" x W: 3-1/4" x D: 1-7/16"
- Display packaged, each
- Use #6 fasteners

SED 671520-1 Chromed brass
 SED 671525-1 Brass



Perko Double Coat Hook

- Chrome plated zinc
 - W: 3" x xD: 3/4"
 - Use #6 fasteners
- PER 1106-DP-CHR



Lamp Towel Racks

- Material: 303 stainless steel
- Mirror finish
- Supplied with stainless steel screws

Part #	Length	Depth	Tube
LMP KB-T-350	13.7"	2"	.4"
LMP KB-T-450	17.7"	2"	.4"



Lamp Shelf Brackets

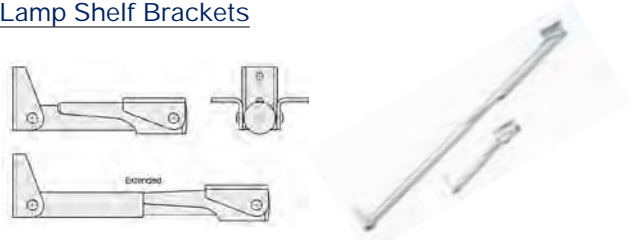

- Made from aluminum and matte finished
- For propping up cabinet doors or shelves
- Comes with fasteners

LMP 38830-25 6.6" to 10.8", max. load 121 lbs
 LMP 38845-25 10" to 17", max. load 132 lbs

Gemlux Folding Bracket

- 304 stainless steel
 Maximum static holding weight: 600 lbs
- Height: 11-7/8"
 - Maximum width: 1-1/4"
 - Protrudes: 6-1/2" in the open position
 - Uses 1/4" fasteners

GEM 3301468



Lamp Angle Brackets

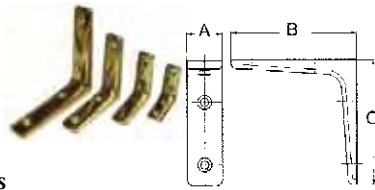

- Polished solid brass
- Supplied with brass screws

Part #	A	B	C
LMP BA-45**	15mm	45mm	45mm
LMP BA-60**	17mm	60mm	60mm
LMP BA-80**	19mm	80mm	80mm

** Limited Quantities

Lamp Angle Brackets

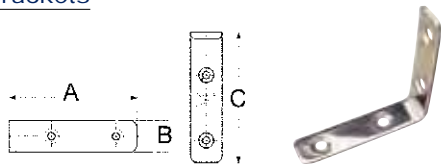

- Mirror finish 18-8 stainless steel
- Supplied with stainless steel screws

Part #	A	B	C	Pack
LMP SU-30/M	31mm	12mm	31mm	Bulk
LMP SU-45/M	46mm	13mm	46mm	Bulk
LMP SU-60/M	61mm	15mm	61mm	Bulk

▶ Also See

Table Brackets pg 1100

Perko Spring Clamps

- Polished stainless steel
- 2/pkg
- Use #6 fasteners

PER 502-DP1-STS 5/8" to 1-1/4"
 PER 502-DP2-STS 1" to 1-3/4"



Sea-Dog Boat Hook Brackets

- Stamped 304 stainless steel
- H: 1-11/16" x W: 1-3/8"
- Fits up to 3/4" to 1" pole
- Use #4 fasteners

SED 491135-1 2/pkg



Beckson Clipmate Holders

- White tempered B-Flex plastic
- Leg design provides permanent holding spring action
- Sold in pairs
- Use #6 pan head fasteners

BEC CM-1 7/8" - 1-1/8"
 BEC CM-2 1-1/2" - 2"



Beckson Plastic Holding Clips

- Non-conductive, non-magnetic and non-corrosive
- 1/8" holes on 3/4" centre for all sizes
- Use #6 flat head fasteners
- 2/pkg



Part #	Colour	Size Range
BEC CLP-1/4"	Black	1/4" - 5/16"
BEC CLP-1/4"W	White	1/4" - 5/16"
BEC CLP-1/2"	Black	3/8" - 1/2"
BEC CLP-1/2"W	White	3/8" - 1/2"
BEC CLP-3/4"	Black	5/8" - 7/8"
BEC CLP-3/4"W	White	5/8" - 7/8"
BEC CLP-1"	Black	7/8" - 1-1/8"
BEC CLP-1"W	White	7/8" - 1-1/8"
BEC CLP-1-1/4"	Black	1-1/8" - 1-3/8"
BEC CLP-1-1/4"W	White	1-1/8" - 1-3/8"
BEC CLP-1-1/2"	Black	1-3/8" - 1-5/8"
BEC CLP-1-1/2"W	White	1-3/8" - 1-5/8"
BEC CLP-1-3/4"	Black	1-5/8" - 1-7/8"
BEC CLP-1-3/4"W	White	1-5/8" - 1-7/8"
BEC CLP-2"	Black	1-7/8" - 2-1/8"
BEC CLP-2"W	White	1-7/8" - 2-1/8"

Sea-Dog Boat Hook Brackets

- Stamped 304 stainless steel
- Fits up to 1-1/4" pole
- 4" H 1" W
- Use 1/4" fasteners

SED 491130-1 2/pkg

Perko Boat Hook Holders

- Polished stainless steel
- Maximum pole size 1-1/2"
- Use #8 fasteners

PER 492-DP-ST 2/pkg

Perko Pole Storage Clips

- Soft black rubber
- Fits 3/4" diameter tubing
- Use #10 PH fasteners

PER 477-DP-BLK 2/pkg

Sea-Dog Pole Storage Clip

- Injection molded black rubber
- Accepts to 3/4" dia. pole

SED 491145-1

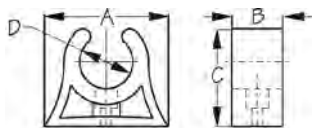
Sea-Dog Boat Hook Brackets

- Injection molded rubber
- Sold in pairs

Part #		A	B	C	D	Pole Size
SED 491341-1	Black	1-1/4"	7/16"	15/16"	1/2"	1/2"
SED 491343-1	Black	1-1/2"	7/16"	1-1/16"	5/8"	5/8"
SED 491345-1	Black	1-3/4"	3/4"	1-1/4"	3/4"	3/4"
SED 491445-1	White	1-3/4"	3/4"	1-1/4"	3/4"	3/4"
SED 491347-1	Black	1-16/16"	13/16"	1-1/2"	7/8"	7/8"
SED 491447-1	White	1-16/16"	13/16"	1-1/2"	7/8"	7/8"
SED 491349-1	Black	2-1/4"	3/4"	1-5/8"	1"	1"
SED 491351-1	Black	2-15/16"	3/4"	2-1/8"	1-1/4"	1-1/4"
SED 491353-1	Black	3-5/16"	3/4"	3-5/16"	1-1/2"	1-1/2"

▶ Also See

Paddle Holders pg 1150

Garelick Utility Mounting Clips

- Made of hardened spring steel
- Rust proof plated and plastic coated
- Holds from 3/4" to 1-1/4" diameter

GAR 75015 2/pkg

Sea-Dog Folding Pole Storage Clips

- Injection molded nylon
- Use #8 FH fasteners

SED 491549-1 1" clip, 2/pkg

SED 491551-1 1-1/4" clip, 2/pkg

SED 491555-1 1-1/2" clip, 2/pkg

Sea-Dog Folding Pole Storage Bracket

- Injection molded nylon/304 stainless
- Max. pole: 1-1/4"
- Use #12 FH fasteners

SED 491140-1 2/pkg

Davis Quick Fist Rubber Clamp

- Heavy duty, transportation grade rubber
- UV resistant
- Withstands extreme heat and cold
- Mounts with one #10 bolt or screw
- Will hold objects from 7/8" to 2-1/4" diameter
- Approximate capacity is 22 lbs each
- Mounting base: 7/8" x 2-3/4"

DIN 540 2/pkg



Fastmount Panel Mounting Systems

Revolutionizes the mounting of ceiling, wall, floor and other panels. The Fastmount PC01 clips used in the system are specifically designed and developed to meet the demanding requirements of the marine industry. Fastmount is an international multi award winning system and is used by more than 300 boatyards in over 35 countries.

The Fastmount system provides a superior ceiling finish with perfect panel alignment every time. Panels can quickly & easily be removed and refitted



- Quick install
- Upholstered panels
- New builds
- Internal & external
- Compatible with Velcro
- Removable
- Strong 5kg per clip
- Precise positioning
- Painted panels
- Refits

Click Here
For More Info

STANDARD CLIPS

FLP PC-01	Clip set - PC-M1B PC-F1A - Male and female self tapping system suitable for most panel mounting applications. 5Kg pull out load per clip. Install with CT-03 and CT-10.
FLP PC-AF1	Auto fit female - Female push fit clip suitable for applications requiring lateral adjustment. Compatible with male clips PC-M1A, PC-M2H, PC-SM2, PC-SM2H, PC-VM1 and PC-VMX. Screw fixed into pre-drilled 35mm hole. No special tools required for installation.
FLP PC-F1A	Self tapping female - Female self tapping clip suitable for most panel mounting applications. Compatible with male clips PC-M1B, PC-M2H, PC-SM2 and PC-VM1. Screws into 16.8mm hole made with CT-07 or CT-13. Install with CT-03.
FLP PC-M1B	Self tapping male - PC-M1A Upgrade - Male self tapping clip suitable for most panel mounting applications. Mounts into PC-F1A, PC-SF1, PC-RF1 and PC-AF1. 5 kg pull out load per clip. Screws into 10mm hole with CT-01 or CT-09. Minimum panel thickness 6mm. Install with CT-10.
FLP PC-M2H	Self tapping male heavy duty (black) - Male self tapping heavy duty clip for use where applications with increased loading. Mounts into PC-F1A, PC-SF1, PC-RF1 and PC-AF1. 10 kg pull out load per clip. Minimum panel thickness 9mm. Screws into 10mm hole with CT-10.
FLP PC-SF1	Surface mount female - Female surface mount screw fix clip for use where a cavity is required. Compatible with male clips PC-M1B, PC-M2H, PC-SM2, PC-SM2H, PC-VM1 and PC-VMX. Screws onto support frame. No special tools required for installation.
FLP PC-RF1-B	Side mount female (brown) - Female side mounting screw fix clip suitable for various side mounting applications. Compatible with male clips PC-M1B, PC-M2H, PC-SM2, PC-SM2H, PC-VM1 and PC-VMX. Screw fixed to frame. Use CT-18 install jig for ceiling applications.
FLP PC-SM2	Surface mount male - Male surface mount clip with SuperGroove base for thinner panels. Mounts into PC-F1A, PC-SF1, PC-RF1 and PC-AF1. 5 kg pull out load per clip. Glue fix with Fastmount Supergroove Adhesive. No special tools required for installation.
FLP PC-SM2H	Same as PC-SM2 - but for heavy duty applications.



LOW PROFILE CLIPS

FLP LP-F8	Self tapping female - Female low profile self tapping clip for use with plywood and MDF type boards. Compatible with male clips LP-M8 and LP-SM8. Install with CT-19 into 25-25.4mm hole.
FLP LP-DF8	Self tapping coarse thread female - Female low profile self tapping clip with coarse thread for use with drywall plasterboard and soft core material. Compatible with male clips LP-M8 and LP-SM8. Install with CT-19 into 25mm hole.
FLP LP-M8A	Self tapping male - Male self tapping low profile clip for plywood and MDF type boards. Mounts into LP-F8 and LP-DF8. 5 kg pull out load per clip. Screws into 10mm hole with CT-09. Install with CT-10.
FLP LP-SM8A	Surface mount male - Male low profile surface mount clip with SuperGroove base for thinner panels. Mounts into LP-F8 and LP-DF8. 5 kg pull out load per clip. Epoxy glue or screw fix. No special tools required for installation.
FLP LP-AF8A	Auto fit female - Female low profile push fit clip with lateral adjustment designed for use with curved panels. Compatible with male clips LP-M8 and LP-SM8. Screw or Fastmount Supergroove Adhesive fix into pre-drilled 35mm hole.



VERY LOW PROFILE CLIPS

FLP VL-F3	Female very low profile clip for surface or recessed mounting. Compatible with male clip VL-M3. 5 kg pull out load per clip set. Screw or Fastmount Supergroove Adhesive fix. No special tools required for installation.
FLP VL-M3	Male very low profile surface mount clip. Compatible with female clip VL-F3. 5 kg pull out load per clip set. Screw or Fastmount Supergroove Adhesive fix. No special tools required for installation.
FLP VL-SS3	Stainless steel screw - Custom type 303 stainless steel screw for fixing VL-M3 into panels down to 5.5mm thick. Supplied with VL-03 clep set. Pan head, #2 square drive. Electroplated mild steel version available code VL-S3.



INTERIOR HARDWARE

Tools	
FLP CP-01ST	Standard center point - Fed plastic stainless steel tip - Standard Profile center point with stainless steel tip to align holes in panel and frame for correct clip alignment. Fits 10mm blind hole in panel drilled with CT-09 or into PC-F1A, PC-SF1, PC-RF1 and PC- AF1.
FLP CP-08ST	Low Profile center point with stainless steel tip to mark harder panel materials for correct clip alignment. Fits into LP-F8 and LP-DF8
FLP VL-CP3	Very Low Profile centre point with stainless steel tip to mark hole centre in panel for correct clip alignment. Fits into both VL-F3 and VL-M3
FLP CT-01	Carbide tip drill 10mm with shoulder - For use with the Standard Profile and Low Profile ranges. For drilling through panel and creating pilot hole for CT-07.
FLP CT-03	Install tool for PC-F1A - For use with Standard Profile clip PC-F1A. Use to install self tapping female PC-F1A with battery drill on correct torque setting
FLP CT-05	Panel removal tool - Stainless steel tool for removing upholstered panels. Not for use with painted panels.
FLP CT-07	Carbide tip step drill - For use with Standard Profile clip PC-F1A. Tungsten tip drill with 16.8mm diameter for drilling 10mm hole in frame
FLP CT-09	Carbide step drill 10mm forstner type - For use with Standard Profile, Low Profile and Metal ranges. For drilling blind holes into the back of panels.
FLP CT-10	Install tool self tapping male clips (aluminium) - For use with Standard Profile, Low Profile and Panel Control range. Use to install self tapping male PC-M1B, PC-M2H, PC-VM1, PC-VMX, PS-150 and LP-M8 with battery drill on correct torque setting.
FLP CT-15	Tap for PC-F1A - For use with Standard Profile clip PC-F1A. Tap tool for tapping thread to fit PC-F1A into fibreglass, aluminium or similar. Either drill hole with CT- 13A or drill out 10mm hole with CT-07 then tap with CT-15.
FLP CT-18DG	Drill guide installation jig for PC-RF1 - Adjustable drill guide for use with the Standard Profile range. Designed for PC-RF1 mounting options.
FLP CT-19	Install tool (metal) for LP-F8 & LP-DF8 - Steel install tool for female Low Profile clip. Use in battery drill with correct clutch setting.
FLP CT-20	Install tool (plastic) for LP-F8 & LP-DF8 - Red plastic moulded Install tool for female Low Profile clip. Use in battery drill with correct clutch setting. For normal use, for large quantity installs use CT-19.



INTERIOR HARDWARE

INSTALLATION TOOL KITS

Standard Profile Range Trial Boat Kit w/clips & tools

12 x PC-F1A, 12 x PC-M1B, 4 x PC-M2H, 4 x PC-SM2, 4 x PC-SM2H, 2 x PC-VM1, 2 x PC-VMX, 4 x PC-RF1, 4 x PC-SF1, 4 x CP-01ST, CT-08. Product information & CD with technical details & installation information.

FLP CT-06T

Yard Kit

Includes: 1 x CT-01, 1 x CT-03, 1 x CT-04, 1 x CT-07 & 1 x CT-09. FLP CT-08

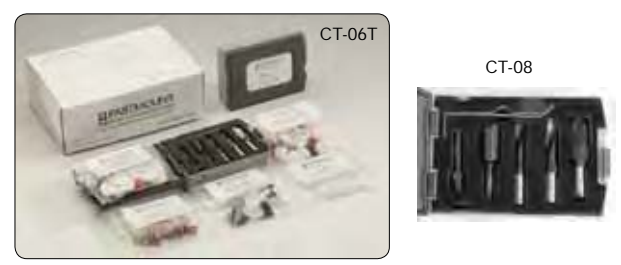

Very Low Profile Trial Kit

Includes 5 x VL-F3, 5 x VL-M3, 5 x VL-F3H, 5 x VL-M3H, 10 x VL-SS3, 4 x VL-CP3, plus information pack.

FLP VL-03T

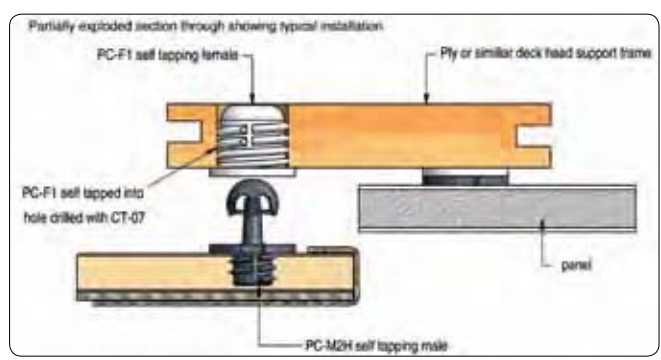

NOVA KOOL

Manufacturing Quality Marine Refrigeration Products for over 30 Years.

- ◆ Refrigerators and freezers in single or two door, side by side and upright configurations
- ◆ Available in DC and AC/DC models
- ◆ Capacities from 1.3 to over 9.1 cubic feet
- ◆ More than 20 distinctive models to choose from

